

SEXPANDER – A small Spektrum DX7 Channel Expander

A normal DX7 (with the little Satellite Receiver) can only send on 7 Channels (4 Channels for Throttle, Gier, Nick & Roll) and 3 Switch-Channels. There are 3 more switches, but their output is not send to the air ☹️

I build this little “Modulator” which reads these additional switches and transmits them over a single channel which is normally used for the Flight-Mode switch. On FlightControl this signal will be decoded “on the fly” using a firmware patch. So you get **10 (ten!)** fully usable channels!

The data uplink runs at ~40 bit/sec (including Sync- and Parity-Bit). The response time is between 50 and 150 ms which is totally fast enough for a switch. (On DX7se the speed is doubled)

Using these additional switches is not destructive, that means you can use them in DX7 itself, such as mixing Elevator on Throttle for example.

If you want to use your DX7 temporarily in normal mode (un-modded), just use a Jumper between GND and MISO (Pin 9+10) on the ISP-Connector (or if you don't have a ISP-Connector, pull down Pin 18 of Tiny2313 directly to GND, via a Switch or something).

Additionally the DX7 will beep every 15 Minutes (7.5 Minutes on DX7se), so you can't forget to turn it off – important for a quiet night without battery-warnings ☺️

For easier configuration I changed the channel assignment as follows:



The schematic itself is very simple as you see. The only thing needed is an Atmel ATtiny2313 and a few wires. The ISP connector is only needed once for programming the code when you don't have a parallel programmer.

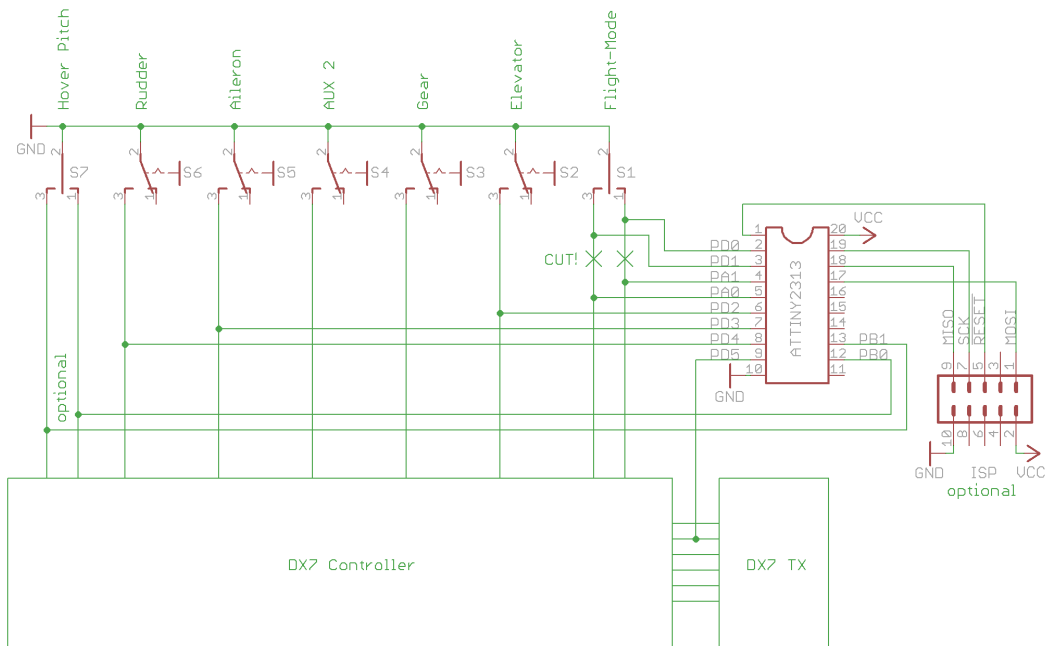

The generated signal looks like this:

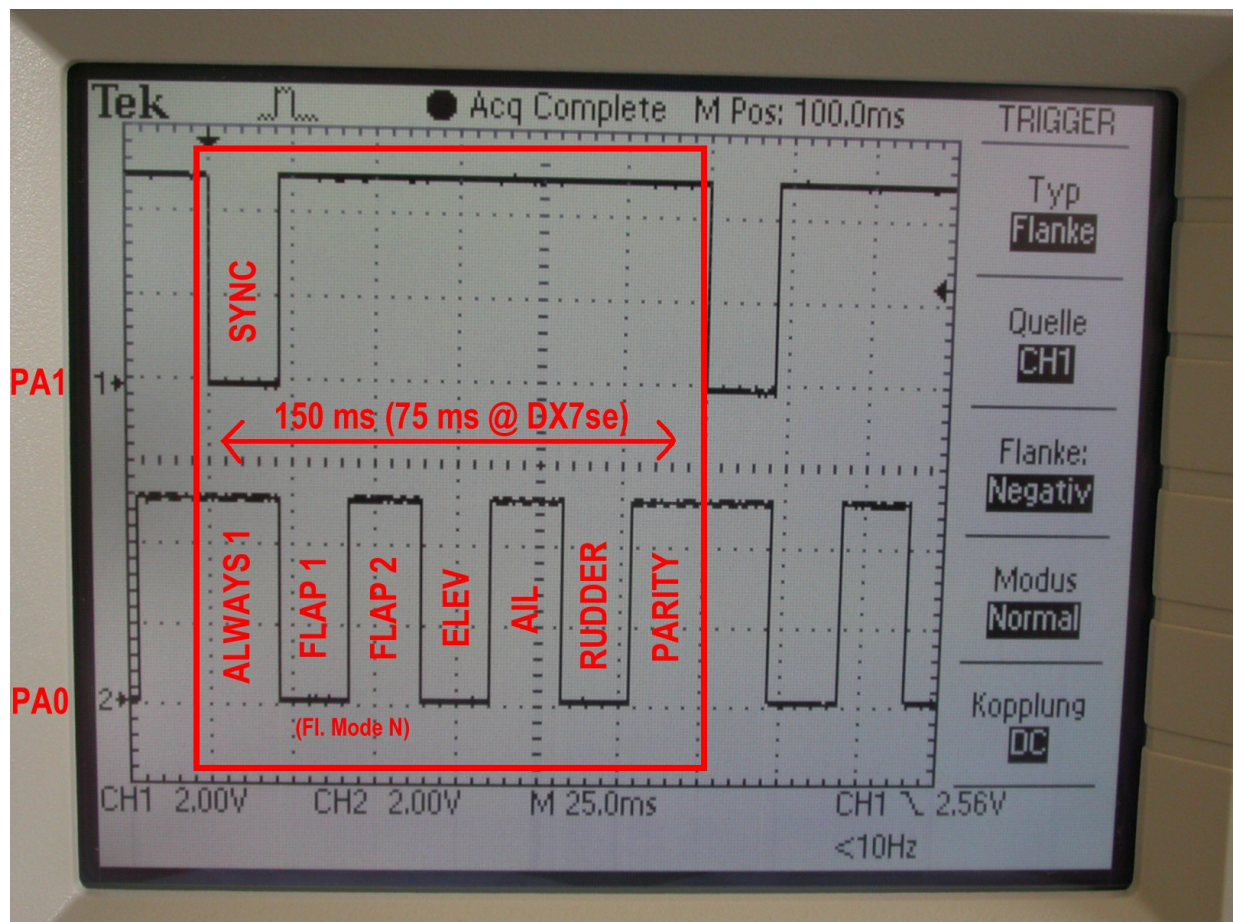

If you want to build your own, take these pictures as a little help:

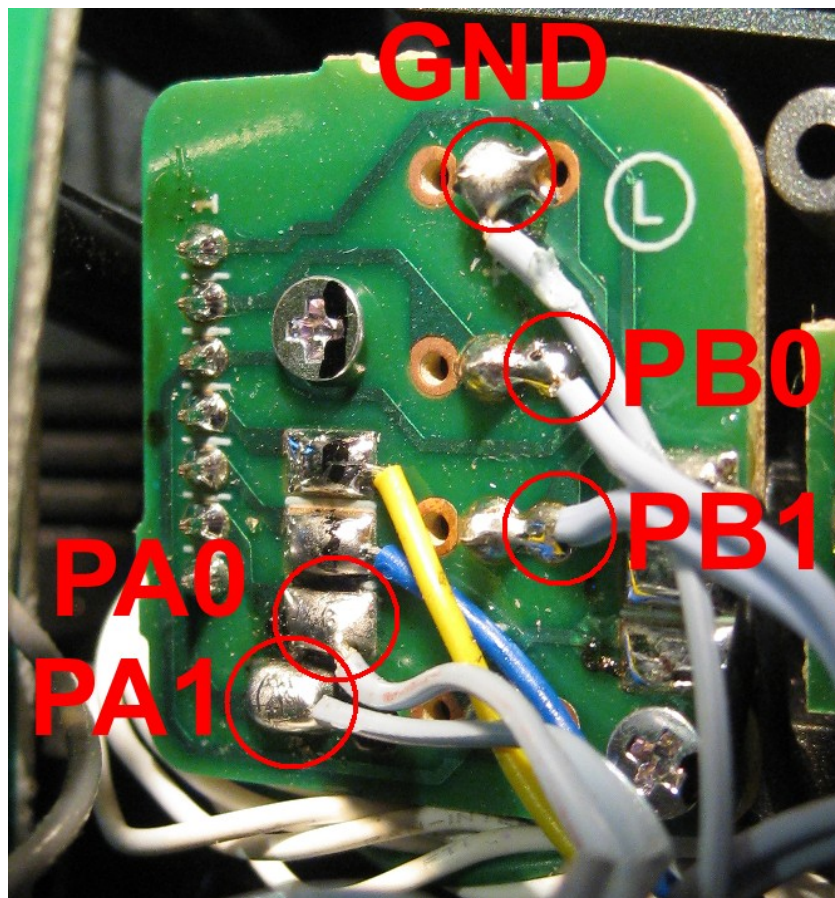

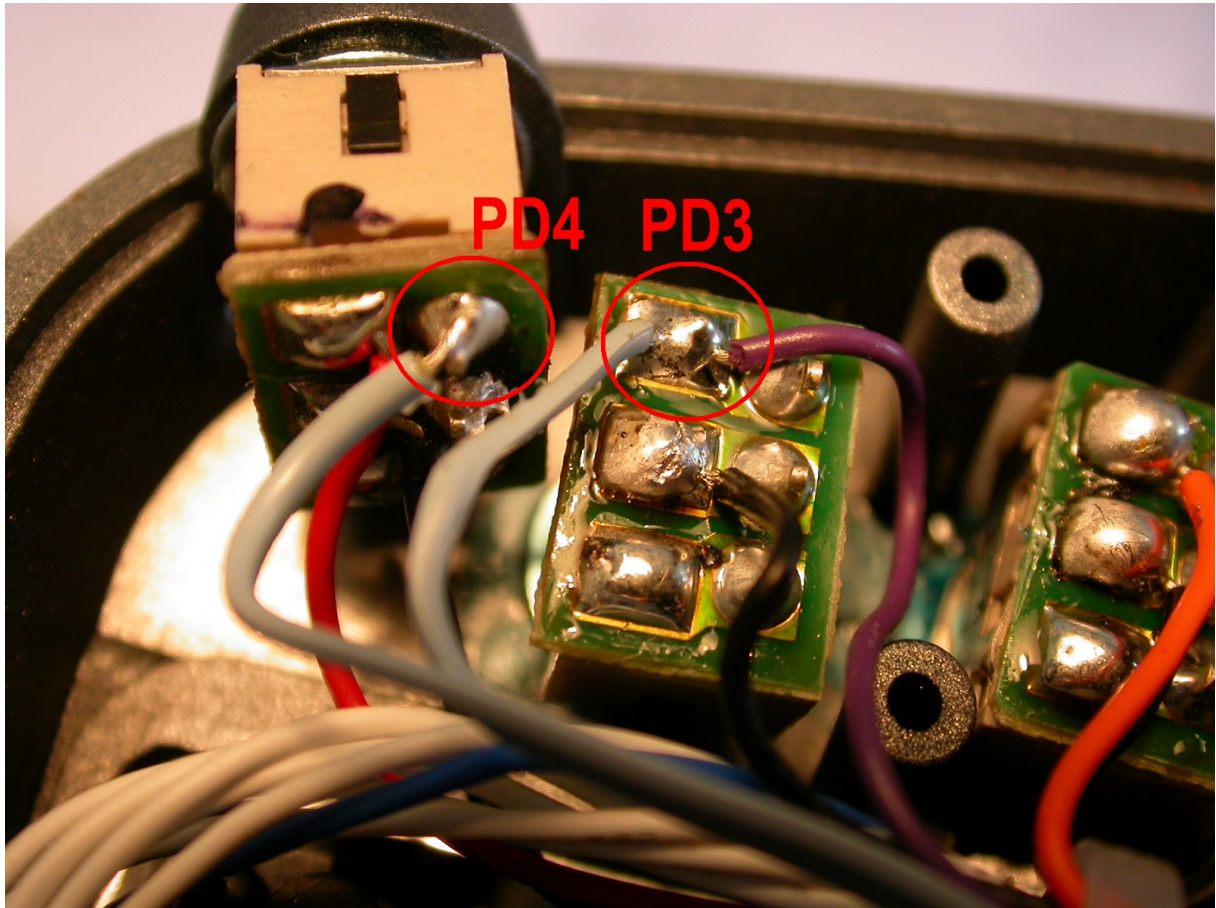
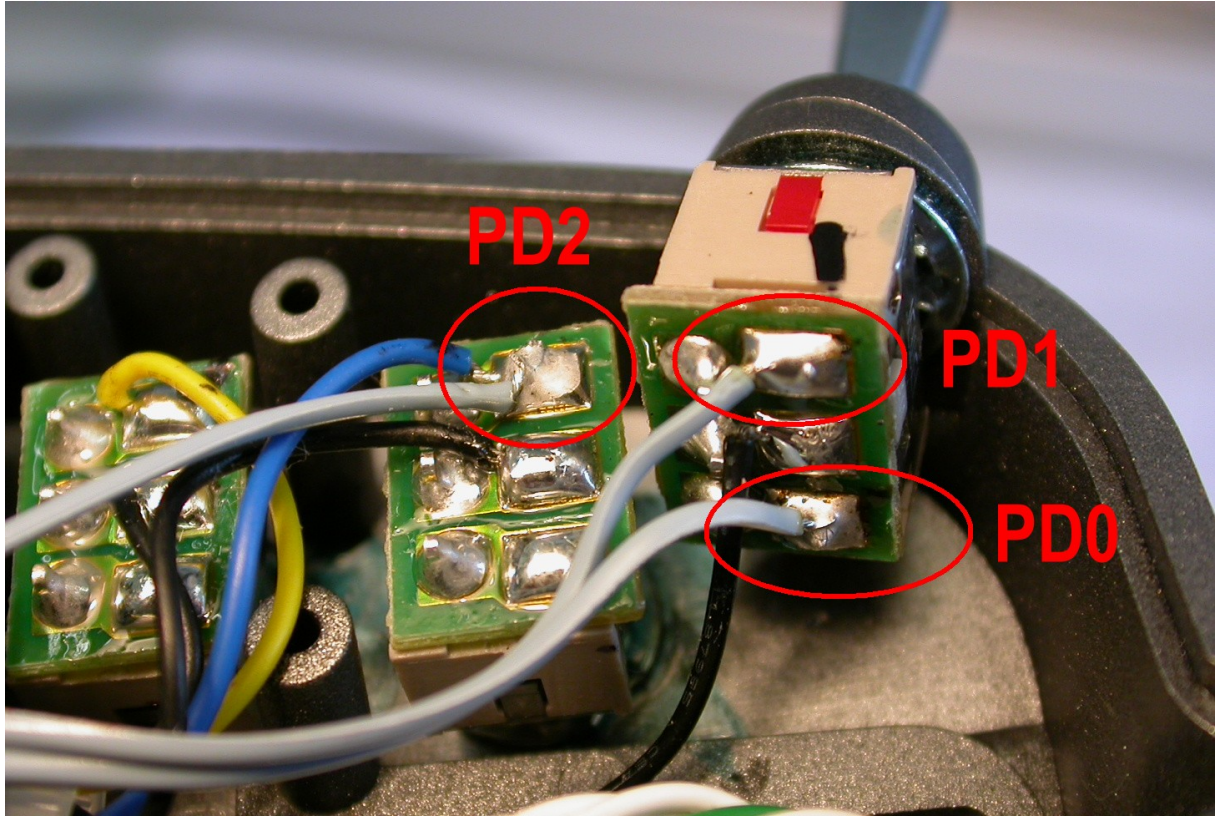

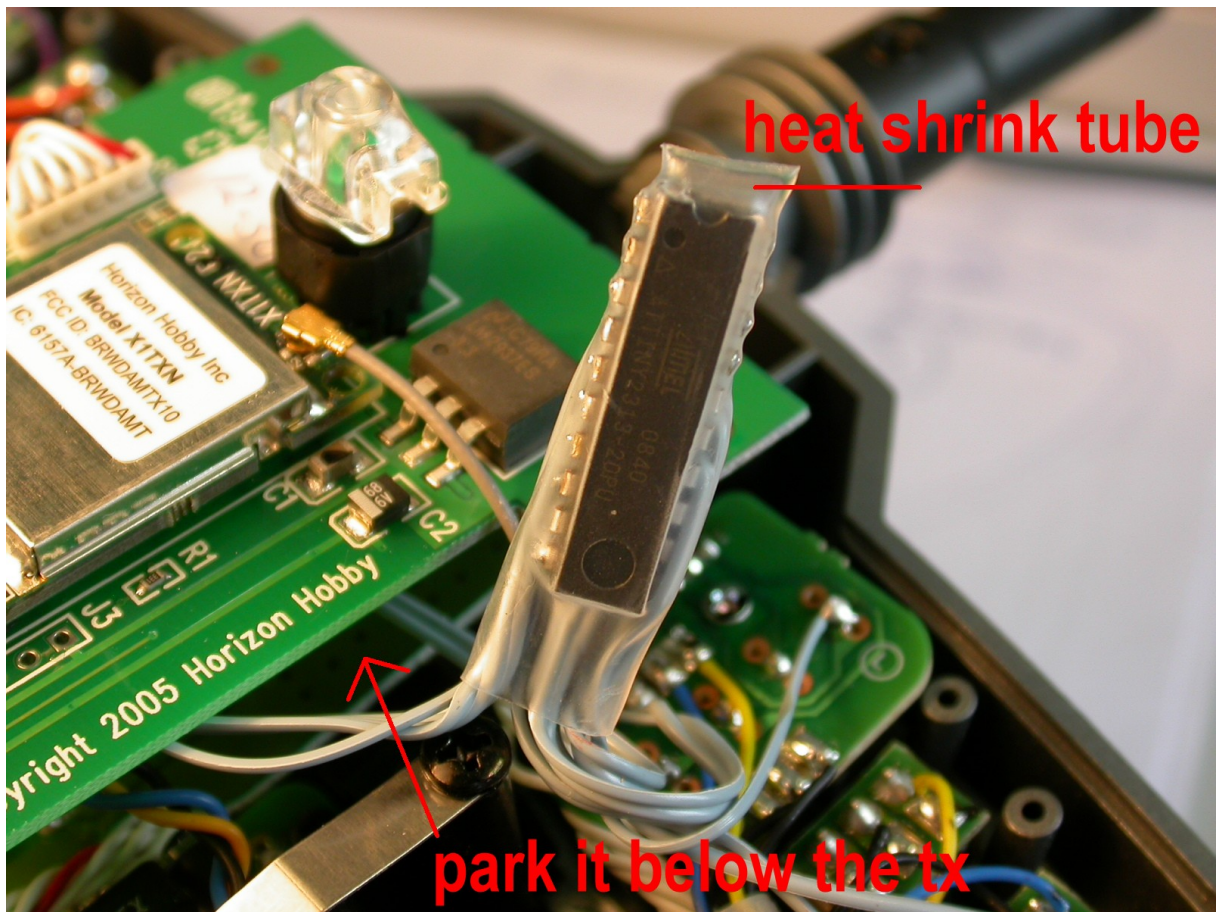
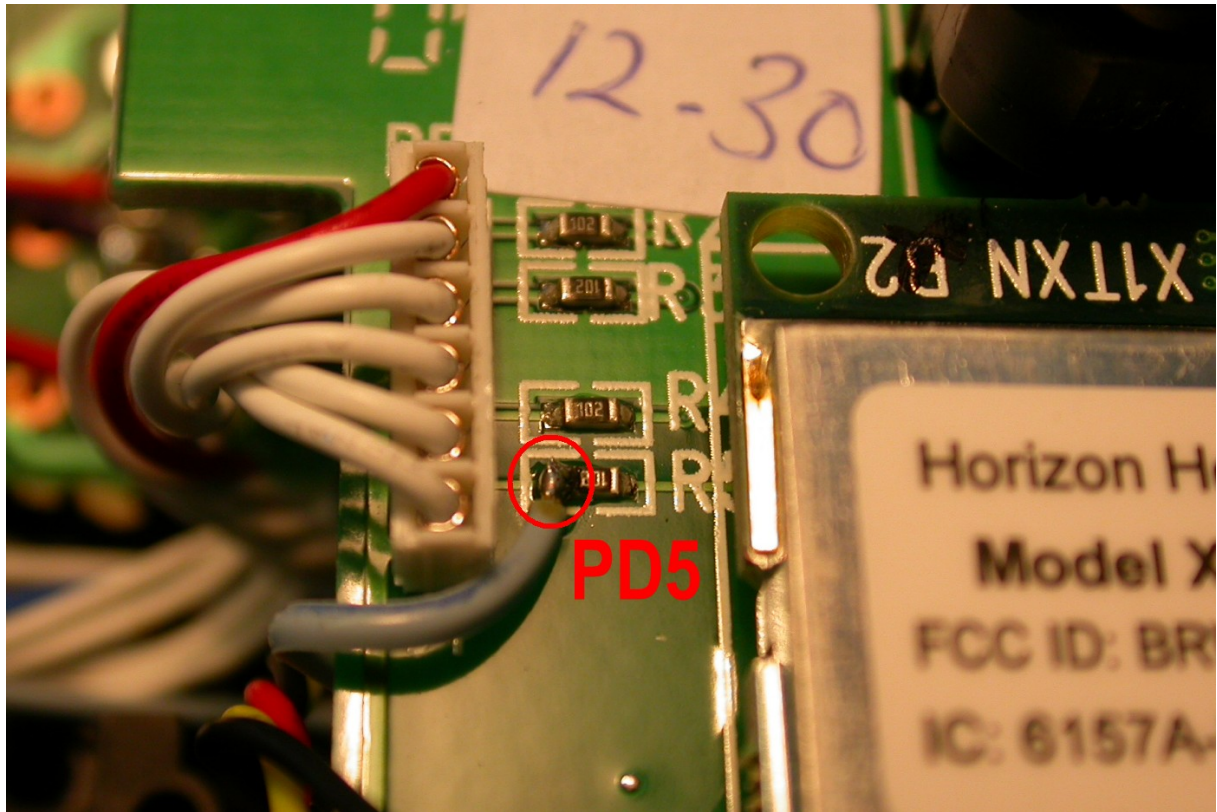

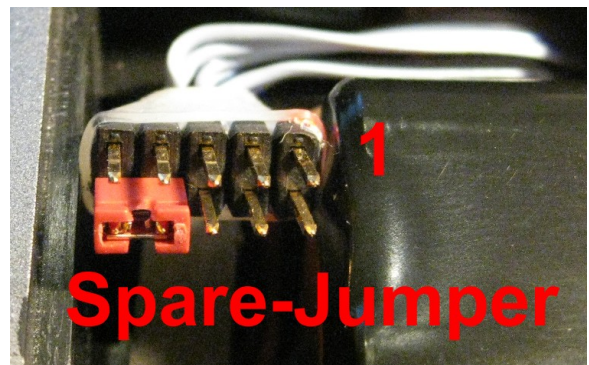
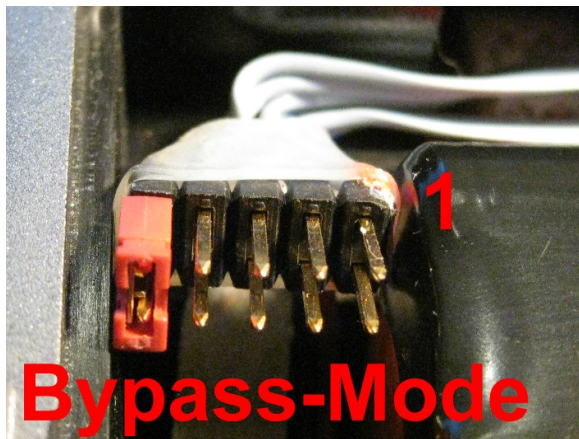
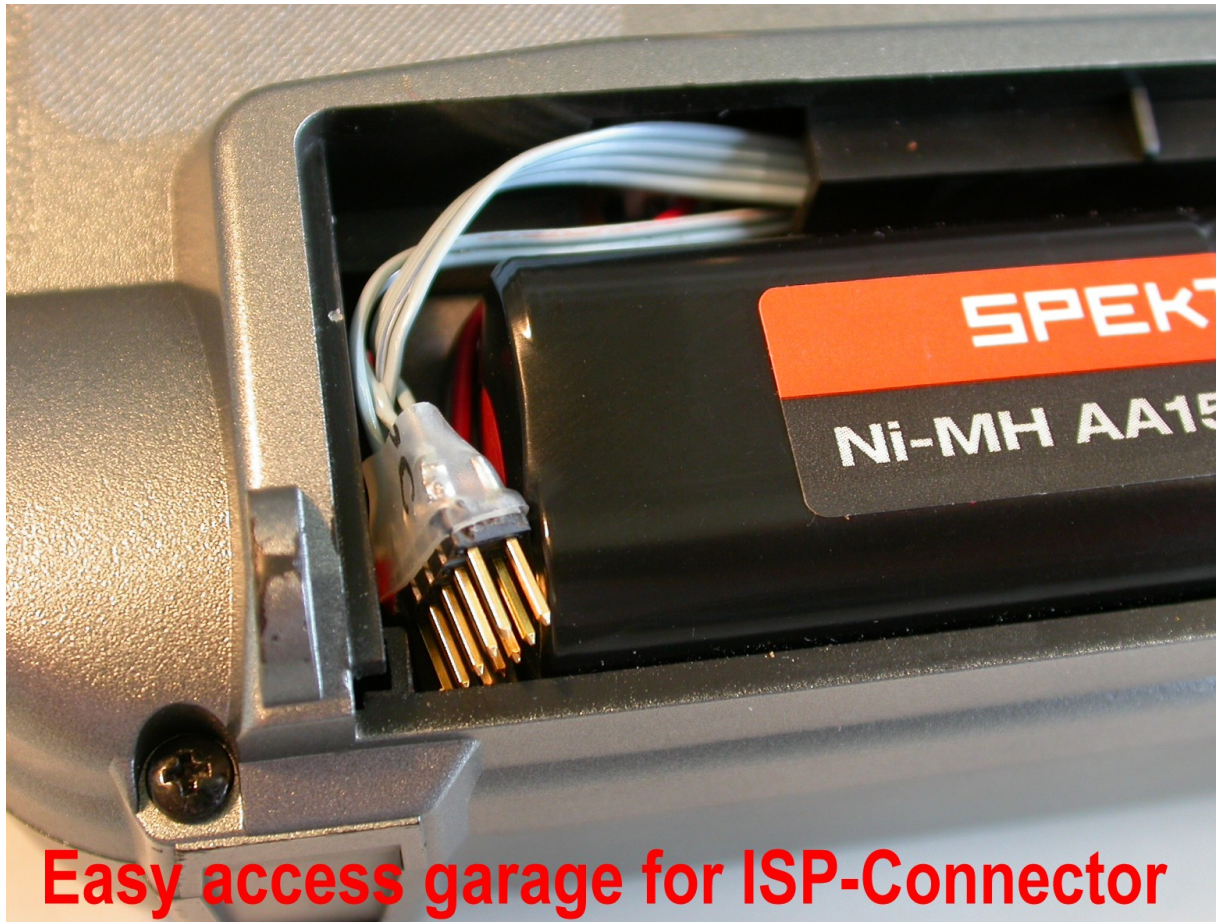

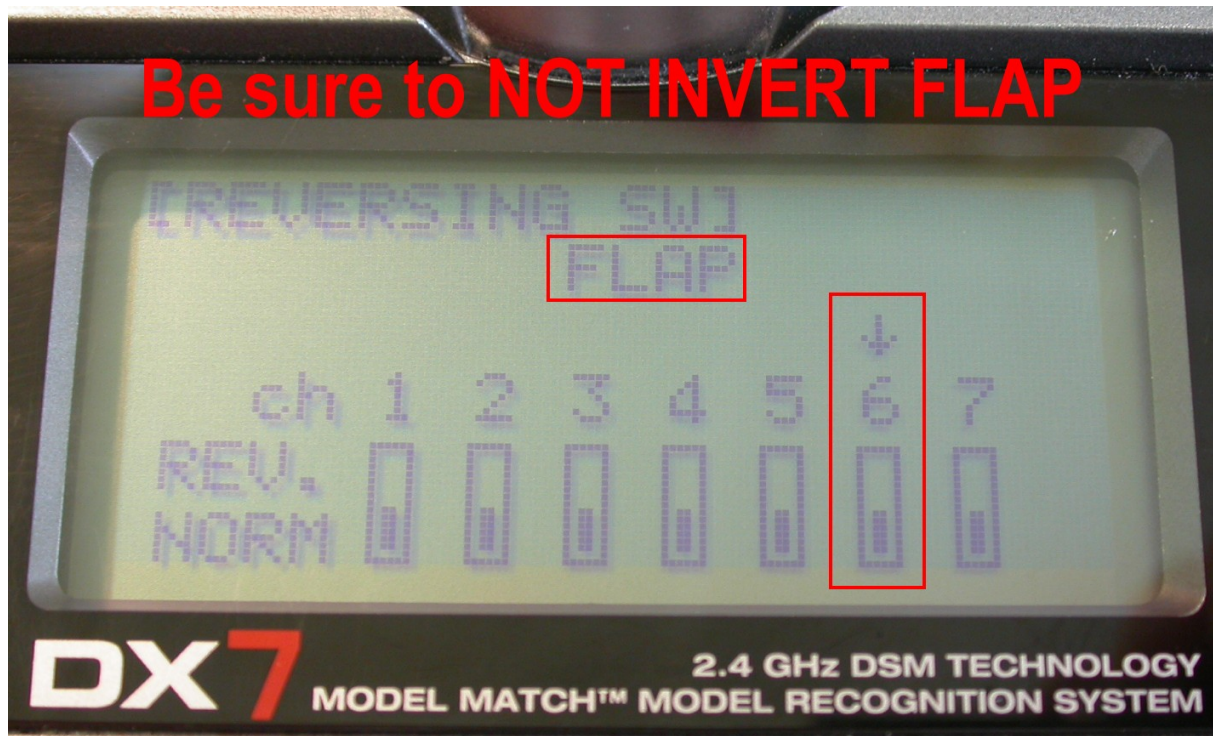

Notes:

- Do not invert the “FLAP” channel, and do not set it to Rocker-Mode – That’s our data-uplink.
- FlightControl firmware patches are available for several versions. But be sure to use the old WinAVR-20060421 compiler, which does not have the performance-problem like newer versions.
- Since FC 0.78b the Patch is inside the official FC-Sourcecode. For compilation you must uncomment the line “#define RECEIVER_SPEKTRUM_EXP” in Spektrum.c
- Precompiled builds are available in [/SVN/Projects/Spektrum-Expander/](#)

Flashing the code into the tiny2313:

You can use the “ISP1” connector from SerCon to flash the code. The Fuse-Bits stay at default (1 MHz internal RC-Oscillator)

I used avrdude to flash code+fuses at once:

```
avrdude -p t2313 -P COM1 -c ponyser -U lfuse:w:0x64:m -U hfuse:w:0xDF:m -U efuse:w:0xFF:m -U flash:w:sexpander.hex
```