

SEXPANDER – A small Spektrum DX7 Channel Expander

A normal DX7 (with the little Satellite Receiver) can only send on 7 Channels (4 Channels for Throttle, Gier, Nick & Roll) and 3 Switch-Channels. There are 3 more switches, but their output is not send to the air ☹️

I build this little “Modulator” which reads these additional switches and transmits them over a single channel which is normally used for the Flight-Mode switch. On FlightControl this signal will be decoded “on the fly” using a firmware patch. Due to limitations of the Kopter-Tool you can only assign the first 8 channels, but channel 9+10 are directly used for LED-Control (J16+J17 Output). So you get **10 (ten!) fully usable channels!**

The data uplink runs at ~40 bit/sec (including Sync- and Parity-Bit). The response time is between 50 and 150 ms which is totally fast enough for a switch. (On DX7**se** the speed is doubled)

Using these additional switches is not destructive, that means you can use them in DX7 itself, such as mixing Elevator on Throttle for example.

By the way, I fixed an old and needless part of averaging inside the FlightControl firmware – That results in 4-times faster response time of the Kopter! (22ms instead of 88ms after moving a stick on DX7, and 11ms instead of 44ms on a DX7**se**)

For easier configuration I changed the channel assignment as follows:



The schematic itself is very simple as you see. The only thing needed is an Atmel ATtiny2313 and a few wires. The ISP connector is only needed once for programming the code when you don't have a parallel programmer.

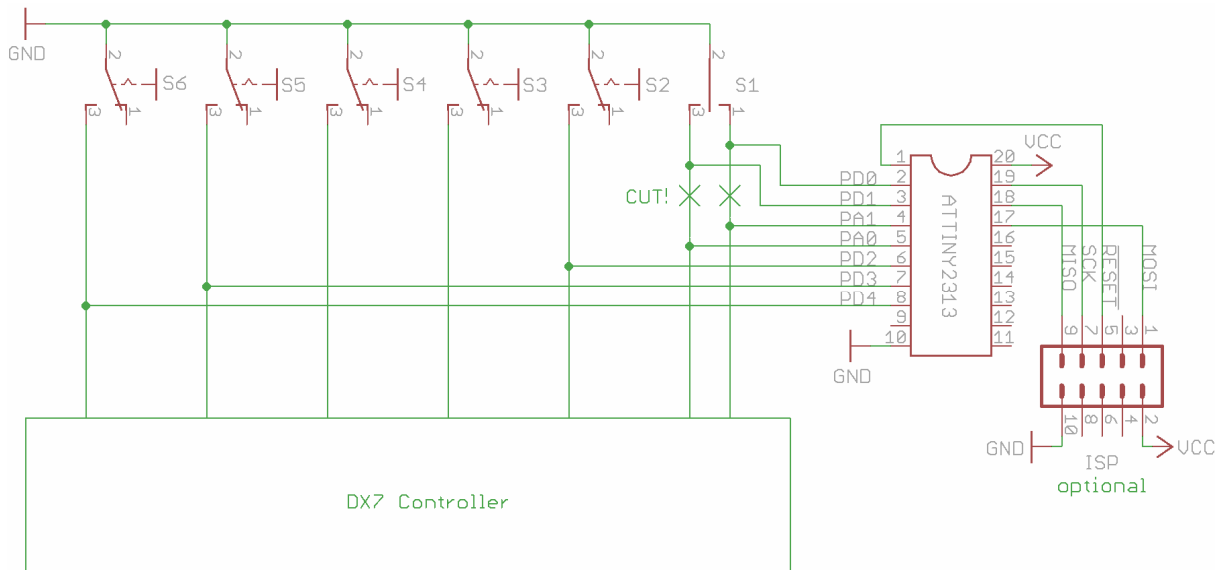

The generated signal looks like this:

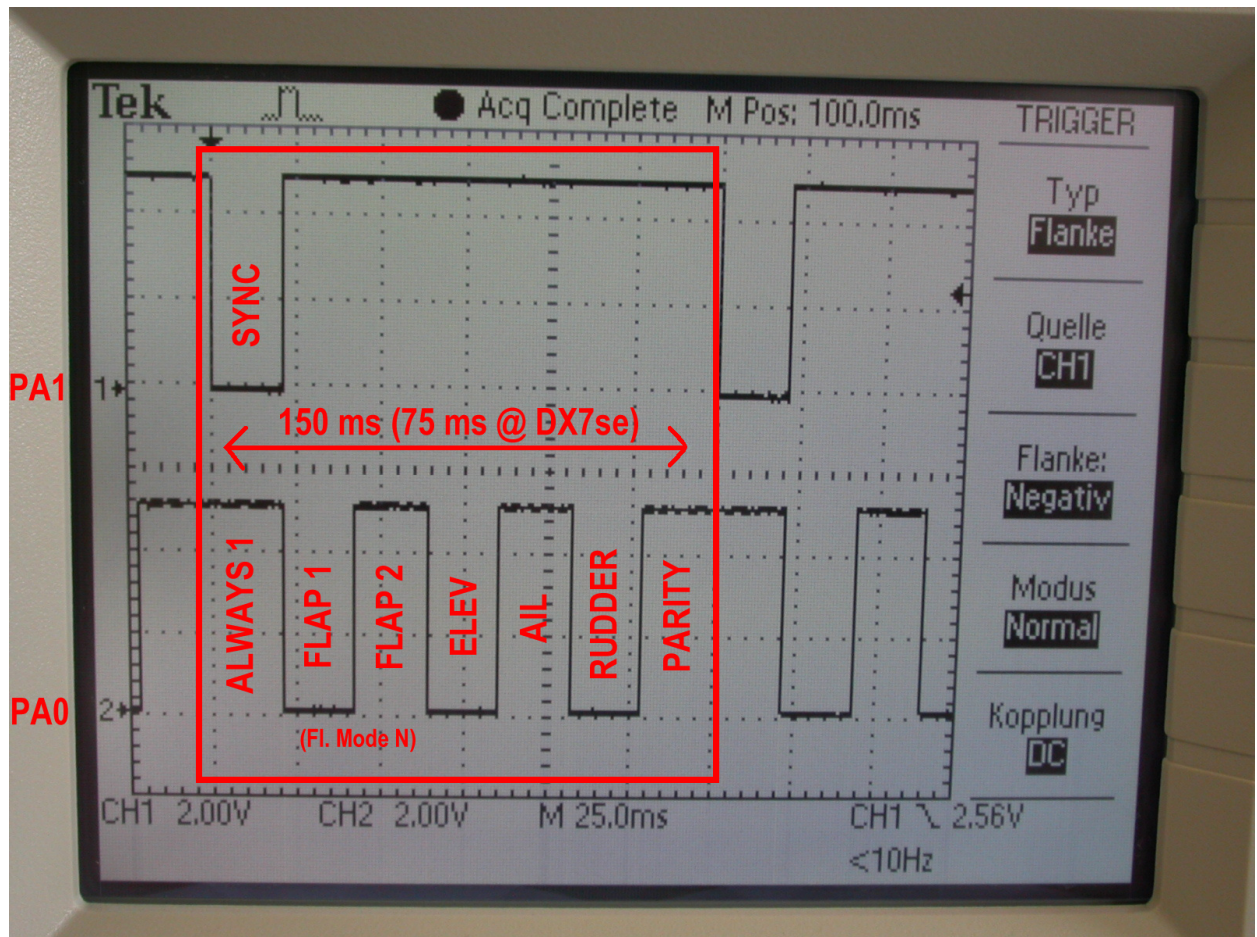

If you want to build your own, take these pictures as a little help:

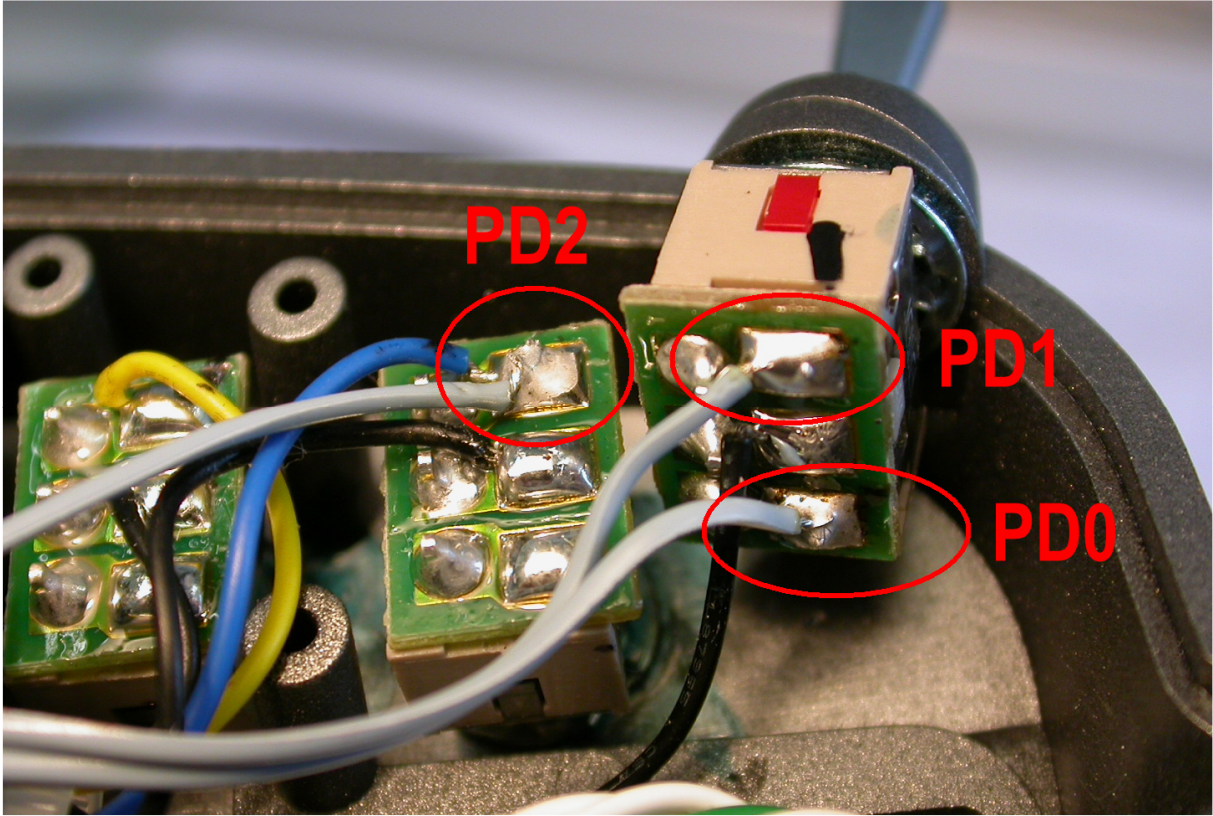

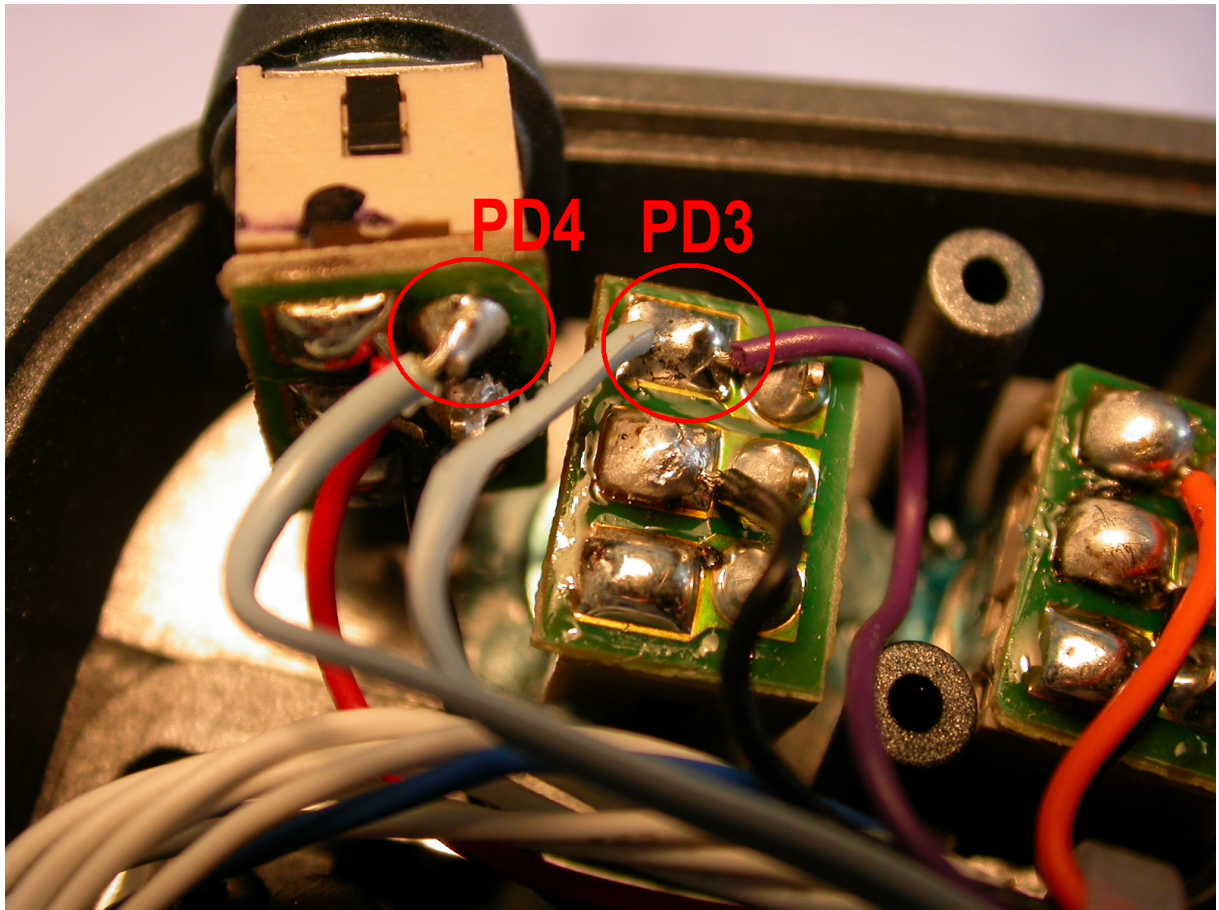
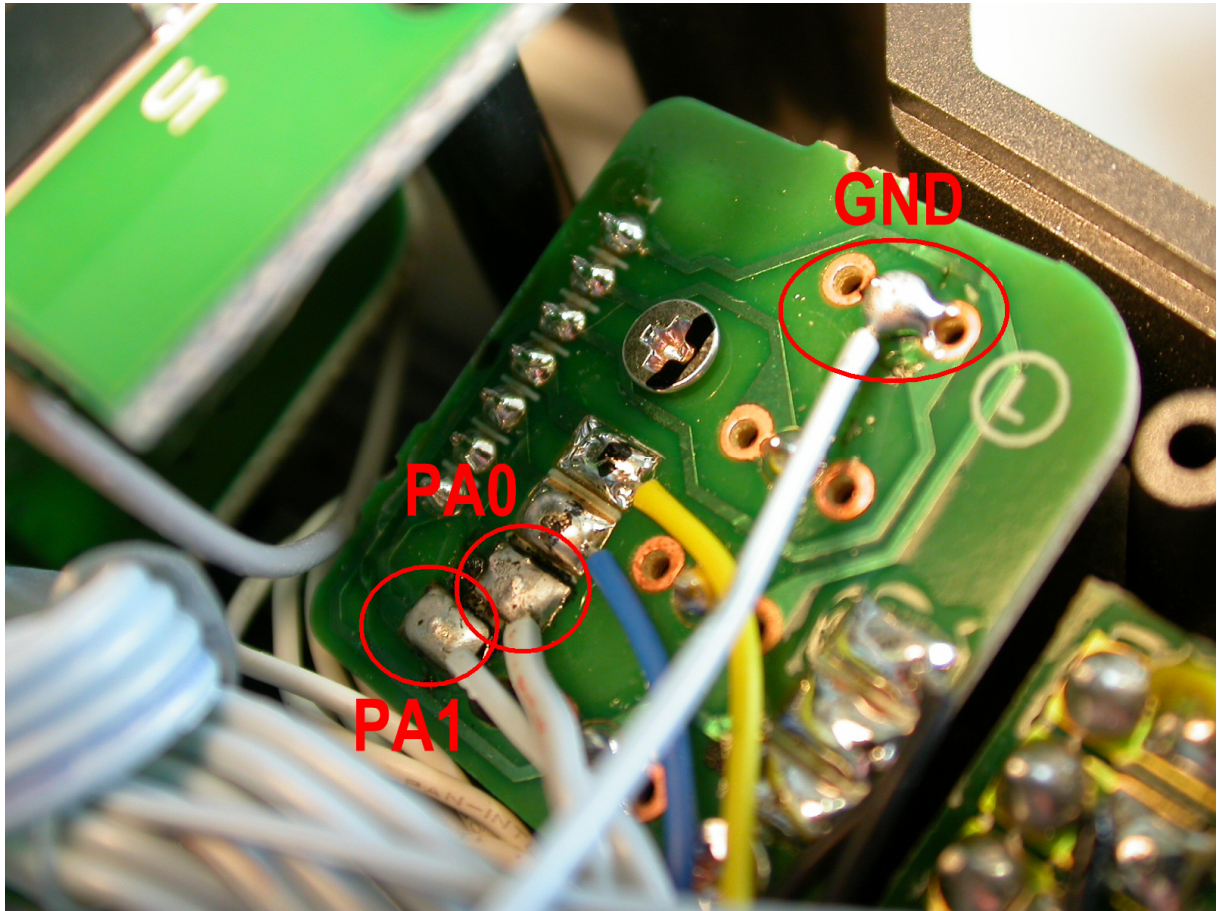

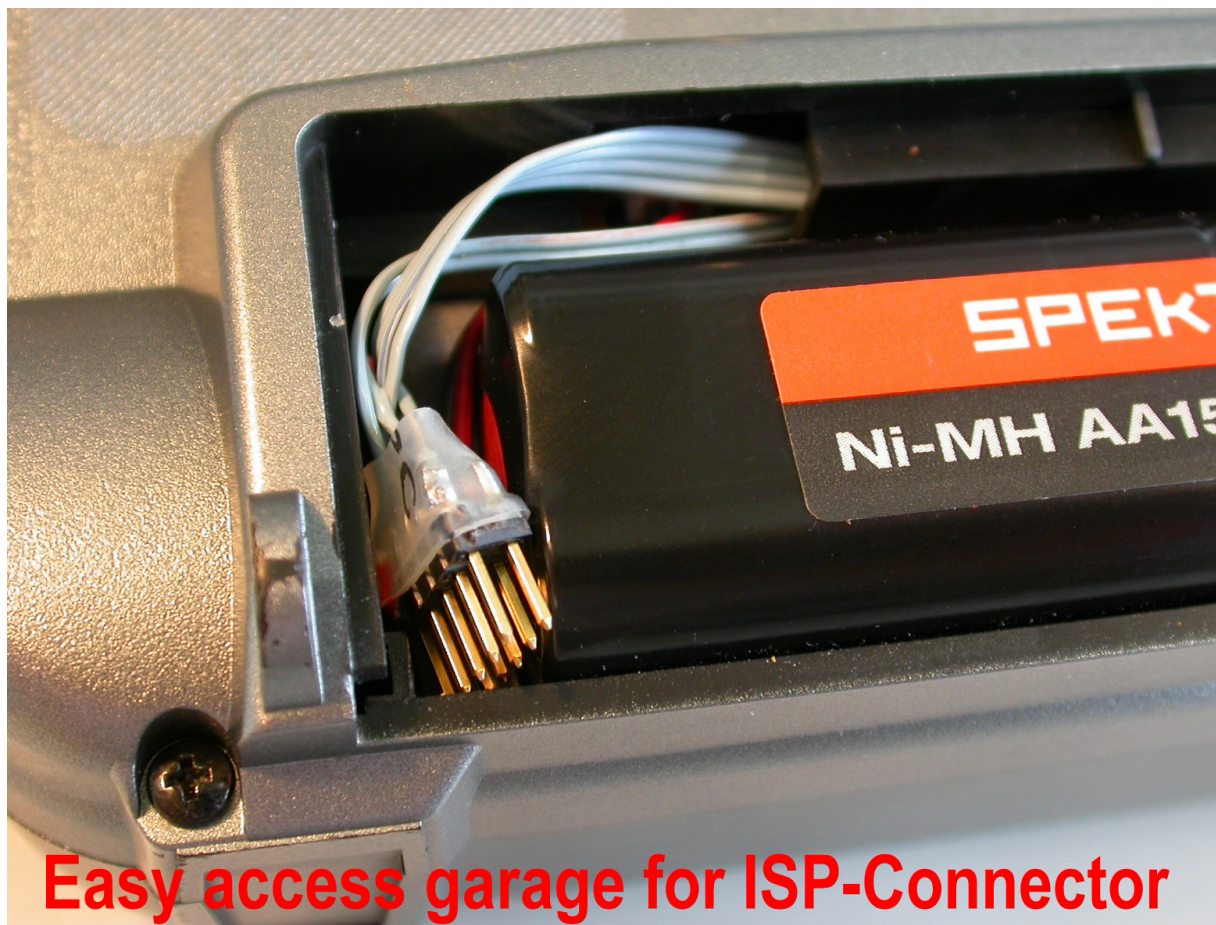
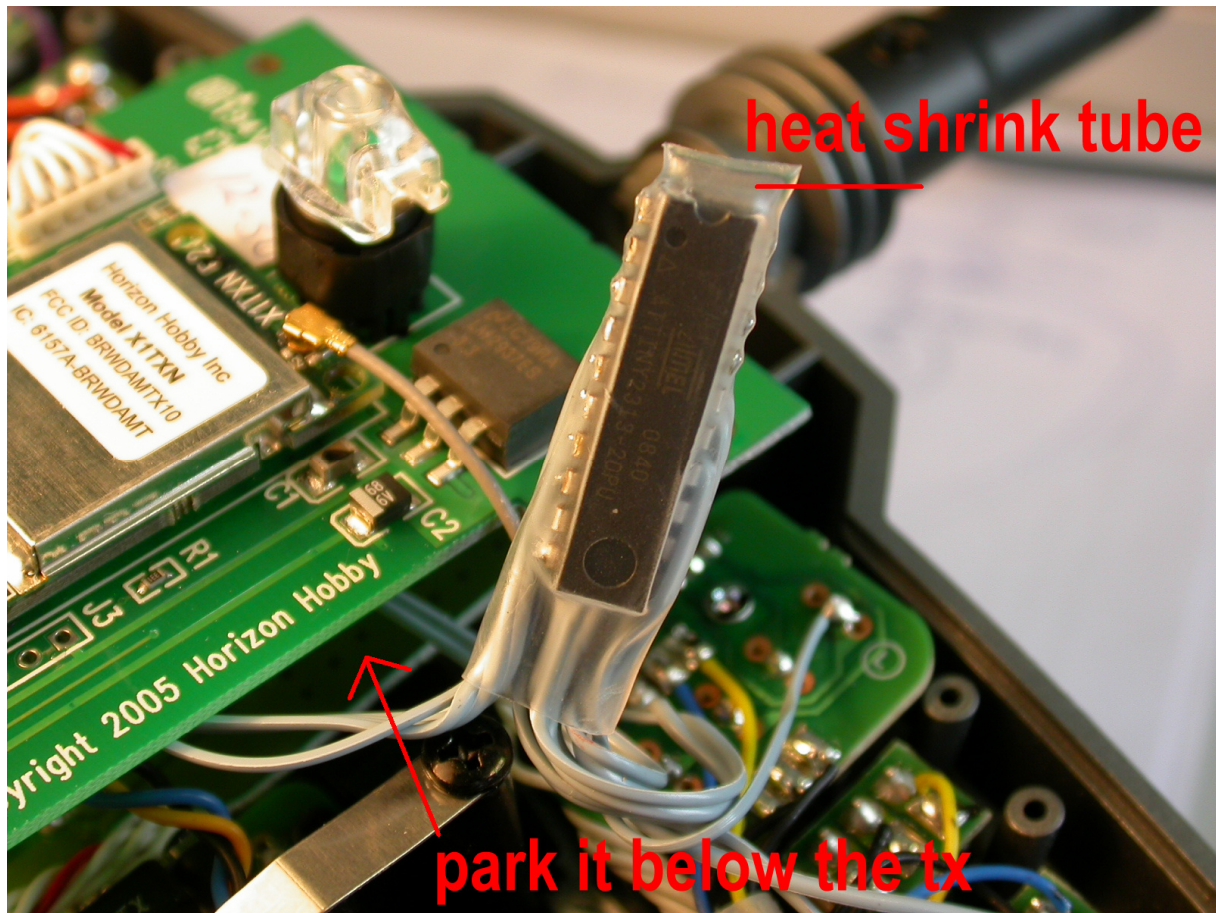

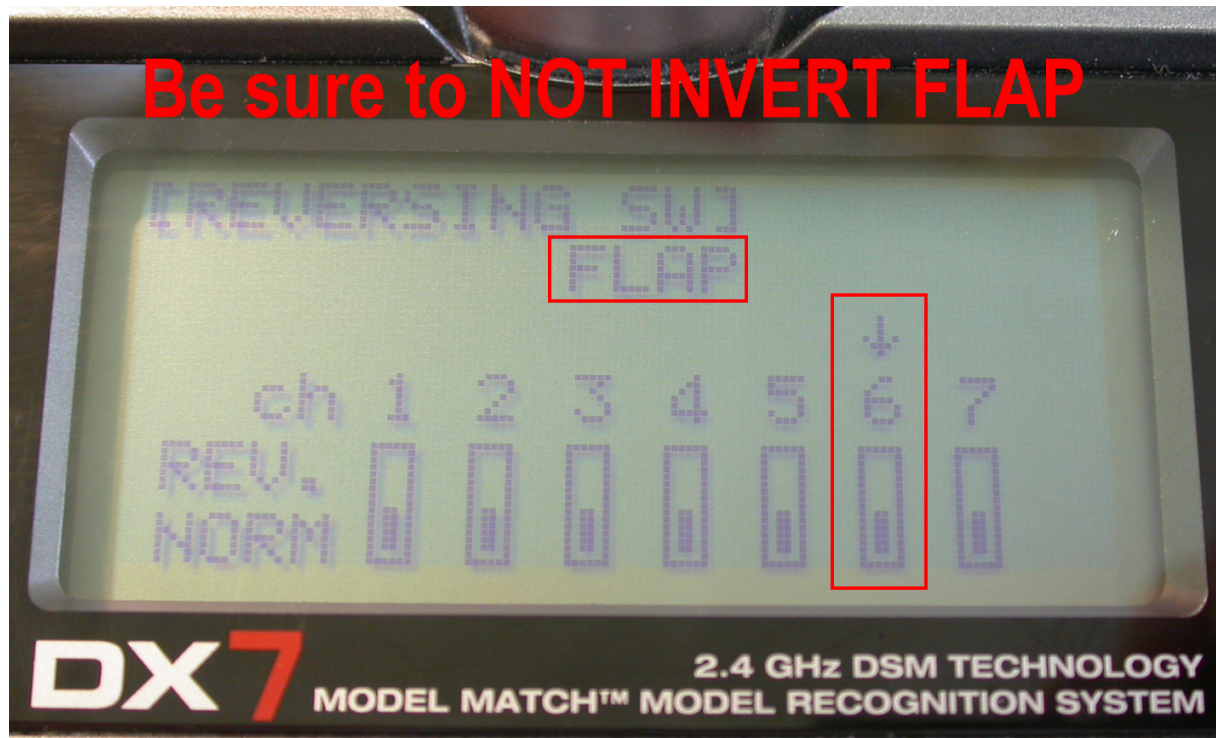

Notes:

- Do not invert the “FLAP” channel – That’s our data-uplink.
- You can use the FlightControl firmware patch on every code branch where the original “Spectrum.c” and “led.c” files are identical to the files included in the official 0.74d build. But be sure to use the old WinAVR-20060421 which does not have the performance-problem like newer versions.
- Precompiled builds are available in /SVN/Projects/Spektrum-Expander/

Flashing the code to the tiny2313:

You can use the “ISP1” connector from SerCon to flash the code. The Fuse-Bits stay at default (1 MHz internal RC-Oscillator)

I used avrdude to flash code+fuses at once, but with another programmer (not SerCon):

```
avrdude -p t2313 -b 115200 -c avr910 -U lfuse:w:0x64:m -U hfuse:w:0xDF:m -U efuse:w:0xFF:m -U flash:w:sexpander.hex
```